

0141.0210 - CAM ML210

FORZA INIZIALE DI ESTRAZIONE / INITIAL EXTRACTION FORCE

40 daN

SFORZO MAX TRANCIO

3000 daN

RÜCKZUGSKRAFT / FORCE INITIALE D'EXTRACTION

FORZA FINALE DI ESTRAZIONE / FINAL FORCE OF EXTRACTION

210 daN

CUTTING MAX FORCE
MAXIMALE SCHNITTKRAFT
EFFORT MAXI DÉCOUPE

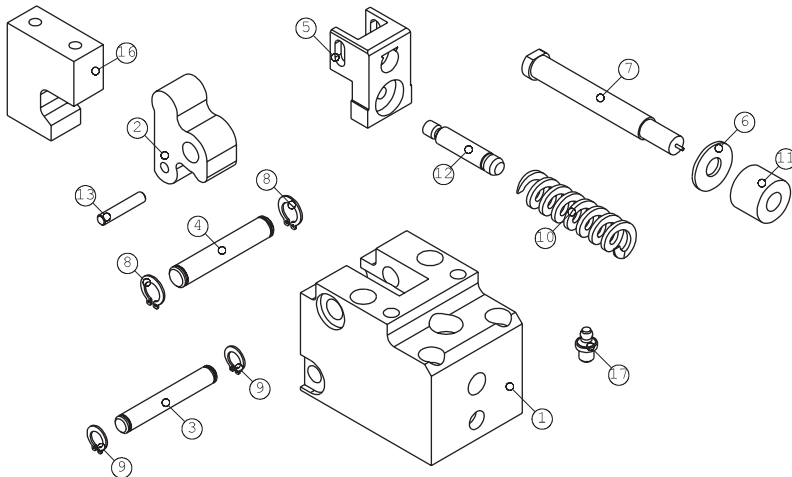

* MAX 30% LUNGHEZZA LIBERA

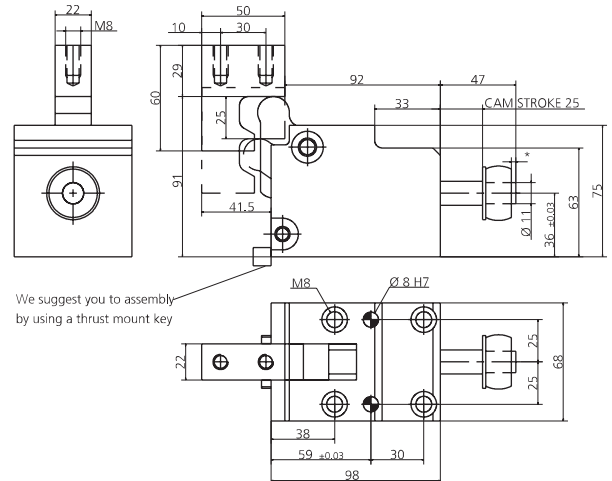

We suggest you to assembly by using a thrust mount key

POS.	CODE	DESCRIPTION	Q.TY
001	8000.0041.0210	CORPO CAMMA / CAM BODY / GRUNDGEHÄUSE	1
002	8001.4041.0210.000	LEVA / LEVER / NOCKE 0	1
002	8001.4041.0210.620	LEVA / LEVER / NOCKE +0.01 +20	1*OPTION
002	8001.4041.0210.640	LEVA / LEVER / NOCKE +20.01 +40	1*OPTION
002	8001.4041.0210.720	LEVA / LEVER / NOCKE -0.01 -20	1*OPTION
002	8001.4041.0210.730	LEVA / LEVER / NOCKE -20.01 -30	1*OPTION
002	8001.4041.0210.740	LEVA / LEVER / NOCKE -30.01 -40	1*OPTION
003	8005.0680.0640.100.001	PERNO / PIN / STIFT	1
004	8005.0680.0640.120.001	PERNO / PIN / STIFT	1
005	8014.4041.0210	PORTA PUNZONE / GATE PUNCH / STEMPELHALTEPLATTE	1
006	8006.0020.0280.111.001	RONDELLA / WASHER / UNTERLEGSCHIBE	1
007	09MJBM2.130.107	MJB_PUNZONE TC CON ESPULSORE / HEADED PUNCH WITH EJECTOR / SCHNEIDSTEMPEL MIT ABSTOSSER 13 107.5	1
007	09MJXM2.130.107	MIX_PUNZONE TC CON ESPULSORE / HEADED PUNCH WITH EJECTOR / SCHNEIDSTEMPEL MIT ABSTOSSER 13 107.5	1*OPTION
007	09MJOM2.130.107	MJO_PUNZONE TC CON ESPULSORE / HEADED PUNCH WITH EJECTOR / SCHNEIDSTEMPEL MIT ABSTOSSER 13 107.5	1*OPTION
007	09MJJM2.130.107	MJJ_PUNZONE TC CON ESPULSORE / HEADED PUNCH WITH EJECTOR / SCHNEIDSTEMPEL MIT ABSTOSSER 13 107.5	1*OPTION
007	09MJHM2.130.107	MJH_PUNZONE TC CON ESPULSORE / HEADED PUNCH WITH EJECTOR / SCHNEIDSTEMPEL MIT ABSTOSSER 13 107.5	1*OPTION
007	09MJKM2.130.107	MJK_PUNZONE TC CON ESPULSORE / HEADED PUNCH WITH EJECTOR / SCHNEIDSTEMPEL MIT ABSTOSSER 13 107.5	1*OPTION
007	09MJNM2.130.107	MJN_PUNZONE TC CON ESPULSORE / HEADED PUNCH WITH EJECTOR / SCHNEIDSTEMPEL MIT ABSTOSSER 13 107.5	1*OPTION
007	09MJLM2.130.107	MJL_PUNZONE TC CON ESPULSORE / HEADED PUNCH WITH EJECTOR / SCHNEIDSTEMPEL MIT ABSTOSSER 13 107.5	1*OPTION
007	09MJRM2.130.107	MJR_PUNZONE TC CON ESPULSORE / HEADED PUNCH WITH EJECTOR / SCHNEIDSTEMPEL MIT ABSTOSSER 13 107.5	1*OPTION
007	09MJVM2.130.107	MJV_PUNZONE TC CON ESPULSORE / HEADED PUNCH WITH EJECTOR / SCHNEIDSTEMPEL MIT ABSTOSSER 13 107.5	1*OPTION
007	09MJYM2.130.107	MJY_PUNZONE TC CON ESPULSORE / HEADED PUNCH WITH EJECTOR / SCHNEIDSTEMPEL MIT ABSTOSSER 13 107.5	1*OPTION
007	09MJZM2.130.107	MJZ_PUNZONE TC CON ESPULSORE / HEADED PUNCH WITH EJECTOR / SCHNEIDSTEMPEL MIT ABSTOSSER 13 107.5	1*OPTION
008	9004.1120.001	SEEGER / SEEGER / SEEGERRING	2
009	9004.1100.001	SEEGER / SEEGER / SEEGERRING	2
010	9009.2000.0760.200	MOLLA / SPRING / FEDER	1
011	9010.1125.020.E090.001	MOLLA IN GOMMA / RUBBER SPRING / ABSTREIFFEDER	1
012	8005.0535.0400.100.001	PERNO / PIN / STIFT	1
013	8005.0310.0310.060.001	PERNO / PIN / STIFT	1
016	8003.0600.0500.220.001	INCLUDINE / ANVIL / TREIBER	1*OPTION
017	9006.002	INGRASSATORE / NIPPLE / SCHMIERUNG	1

002 (8001) LEVA / LEVER / NOCKE

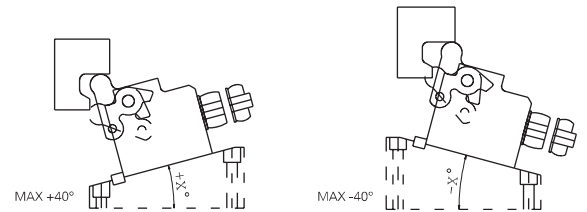

8124.0141.0210 KIT ADATTAMENTO STARK STRIPPER / STARK-STRIP ADAPTION KIT / STARK-STRIP ADAPTIONSSATZ

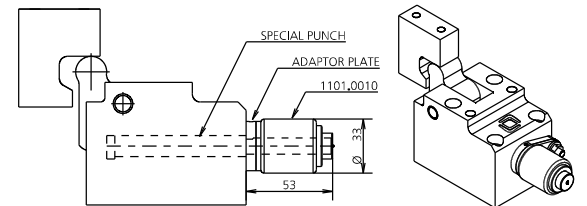

Il kit comprende il punzone, la piastrina di adattamento e le viti di fissaggio.

Lo stark-stripper va ordinato a parte (vedi la sezione del catalogo dedicata)

The kit includes the punch, the adapter plate and the fixing screws.

The stark-stripper must be ordered separately (see the dedicated catalog section)

Das Kit enthält den Stempel, die Adapterplatte und die Befestigungsschrauben.

Der Stark-muss separat bestellt werden (siehe den entsprechenden Abschnitt des Katalogs)

007 (09M) PUNZONE TC / HEADED PUNCH / SCHNEIDSTEMPEL ISO8020

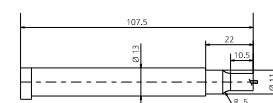

007 (09S) PUNZONE SPECIALE PER KIT 8124 / SPECIAL PUNCH FOR KIT 8124 / SPEZIALSTEMPEL FÜR BAUSATZ 8124

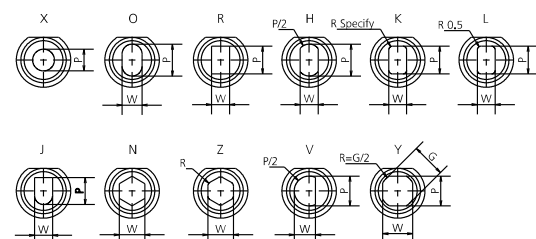
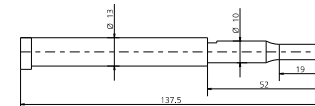

MODELLO D'ORDINE / ORDER EXAMPLE / BESTELLBEISPIEL / MODÈLE DE COMMANDE

MODEL **0141.0210** INCLINATION **+10°** OPTION CODE **8001.4041.0210.620**